

YOUTH DO NOT DRAG,  
TROT CIRCLE

# CLE ELUM RANCH 2024 RANCH 9 ALL RANCH TRAIL CLASSES

- BE READY AT CONE
- TROT OVER LOGS AND AROUND TREE TO LOG
- SIDE PASS LEFT OVER LOG TO GATE.  
OPEN GATE, WALK THROUGH, CLOSE GATE
- LOPE (RL) CIRCLE AROUND TREE, TROT OVER POLES
- LOPE (LL) OVER LOGS, EXTEND LOPE, COLLECT LOPE AND WALK TO DRAG
- REMOVE ROPE DRAG LOG AROUND STAND AND REPLACE ROPE
- TURN 180 DEGREES TO LEFT, EXTENDED TROT TO BRIDGE
- WALK OVER BRIDGE, STOP BACK 5 OR MORE STEPS  
DISMOUNT (CAN USE BLOCK)
- WALK TO LOGS, ROLL MIDDLE LOG WITH FOOT TO OTHER END.  
( MAY GROUND TIE OR LEAD HORSE FOR LOG ROLL)
- LEAD HORSE OUT

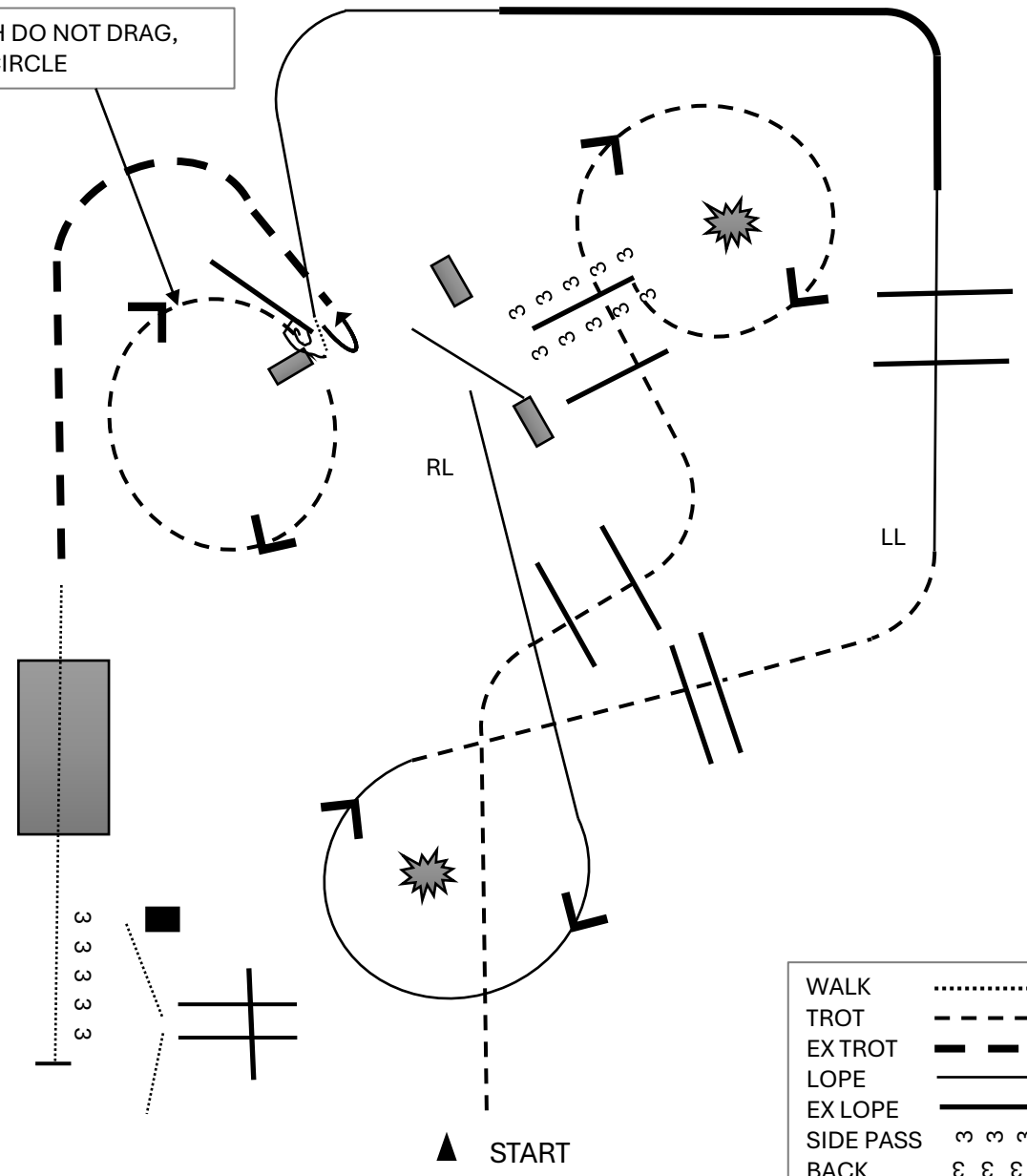

WALK	.....
TROT	- - - - -
EXT TROT	— — — — —
LOPE	=====
EX LOPE	—————
SIDE PASS	3 3 3 3
BACK	ε ε ε ε ε

FINISH

▲ START

# Bronze Classic

## Ranch Riding

Show Date: 07-19-2024

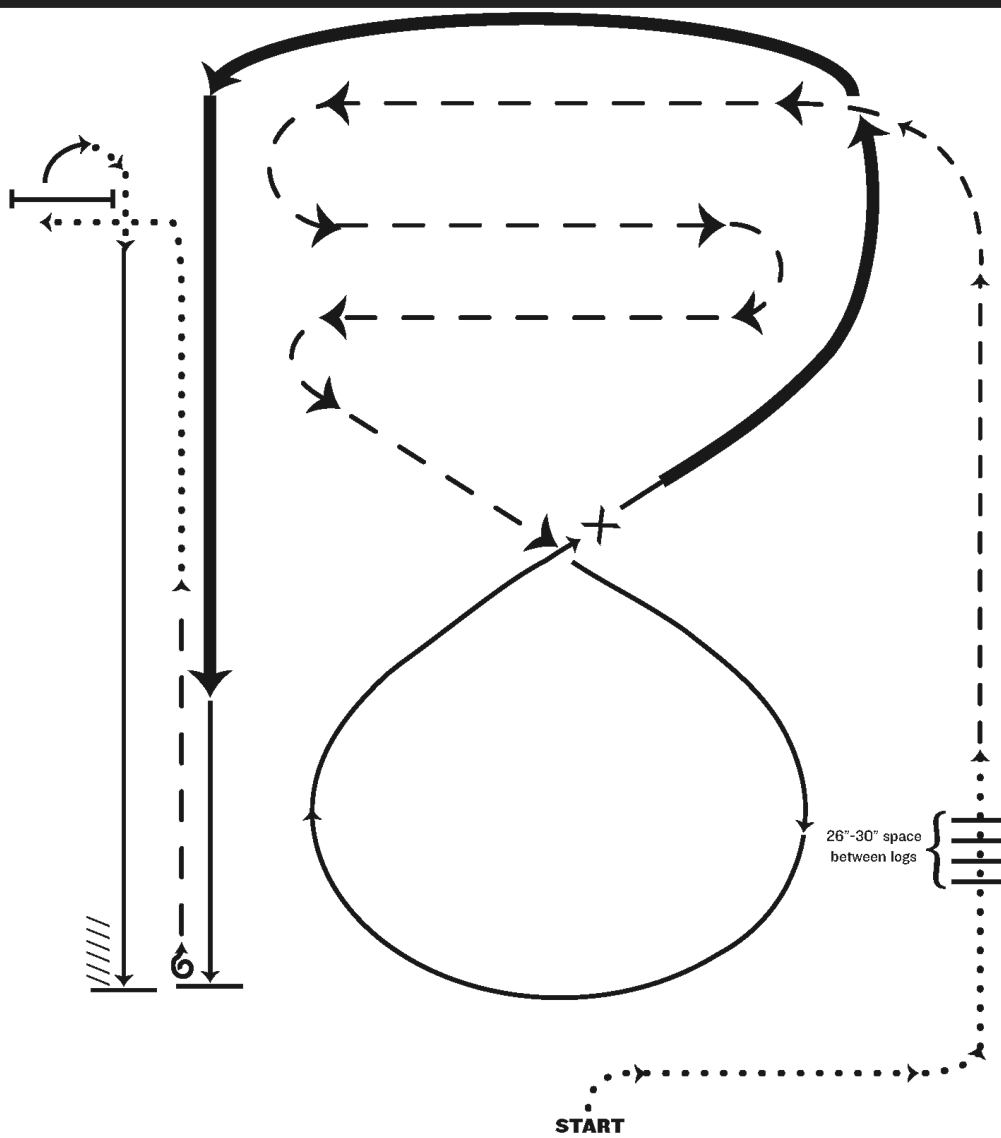

1. Walk
2. Walk over logs
3. Trot
4. Extended trot serpentine
5. Lope right lead
6. Change leads (simple or flying)
7. Extended lope (left lead), collect lope
8. Stop, 1 1/2 turn, either direction
9. Trot
10. Walk to gate
11. Right hand push gate
12. Walk, lope left lead
13. Stop and back

Note: The drawn description of this pattern is only intended for the general depiction of the pattern. Exhibitors should utilize the arena space to best exhibit their horses.

[RR/AQHA-13]

Pattern Provided by:

# Bronze Classic

## Reining

Show Date: 07-19-2024

### REINING PATTERN 4

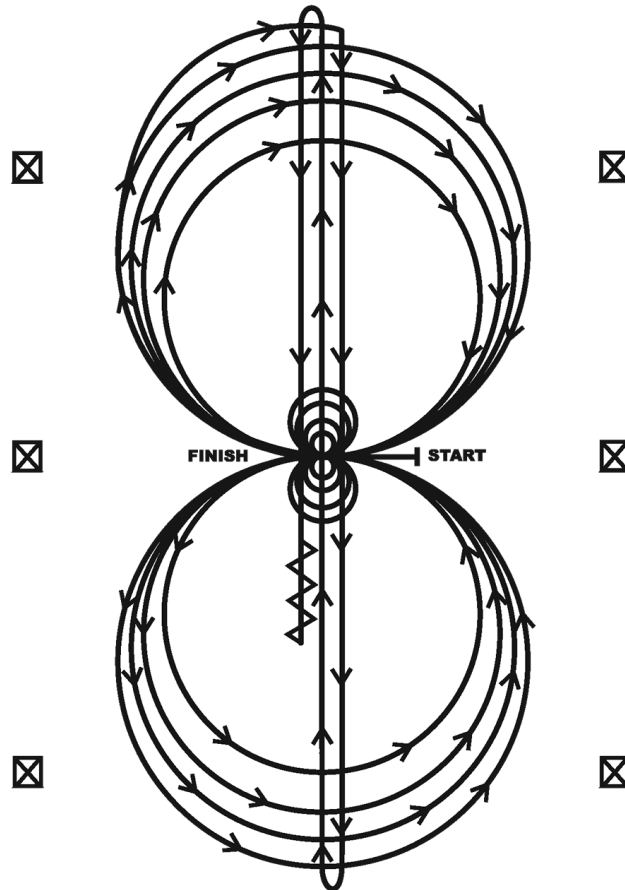

Horses may walk or jog to the center of the arena. Horses must walk or stop prior to starting pattern. Beginning at the center of the arena facing the left wall or fence.

1. Beginning on the right lead, complete three circles to the right: the first two large and fast; the third circle small and slow. Stop at the center of the arena. Hesitate.
2. Complete four spins to the right. Hesitate.
3. Beginning on the left lead, complete three circles to the left: the first two circles large and fast; the third circle small and slow. Stop at the center of the arena. Hesitate.
4. Complete four spins to the left. Hesitate.
5. Beginning on the right lead, run a large fast circle to the right, change leads at the center of the arena, run a large fast circle to the left, and change leads at the center of the arena. (Figure 8)
6. Continue around previous circle to the right. At the top of the circle, run down the middle to the far end of the arena past the end marker and do a right rollback—no hesitation.
7. Run up the middle to the opposite end of the arena past the end marker and do a left rollback—no hesitation.
8. Run past the center marker and do a sliding stop. Back up to the center of the arena or at least ten feet (three meters). Hesitate to demonstrate completion of the pattern.

[R/AQHAP-4]

Pattern Provided by:

# Bronze Classic

## Showmanship (10 & Under)

Show Date: 07-19-2024

w w w . H o r s e S h o w P a t t e r n s . c o m

w w w . H o r s e S h o w P a t t e r n s . c o m

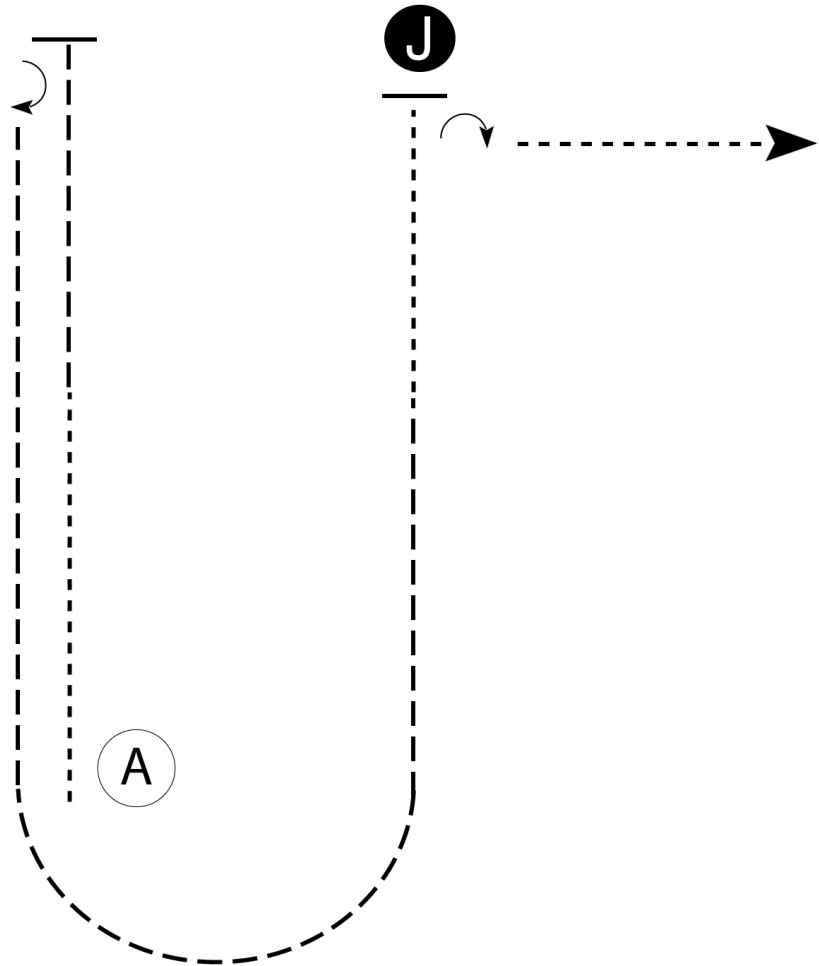

Be ready at A.

1. Walk halfway from A to judge.
  2. Trot until even with judge.
  3. Stop and perform a 180 degree turn.
  4. Trot to and around A and halfway to judge.
  5. Walk to judge.
  6. Stop and set up for inspection.
  7. When dismissed, perform a 90 degree turn.
  8. Walk straight away from judge.
- Follow the instructions of your ring steward.

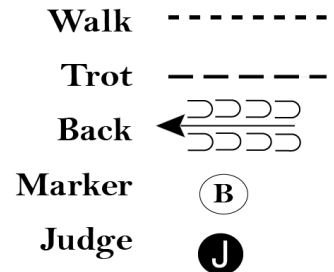

[S/WT-77]

Pattern Provided by:

# Bronze Classic

## Showmanship

Show Date: 07-19-2024

W W W . H O R S E S H O W P A T T E R N S . C O M

W W W . H O R S E S H O W P A T T E R N S . C O M

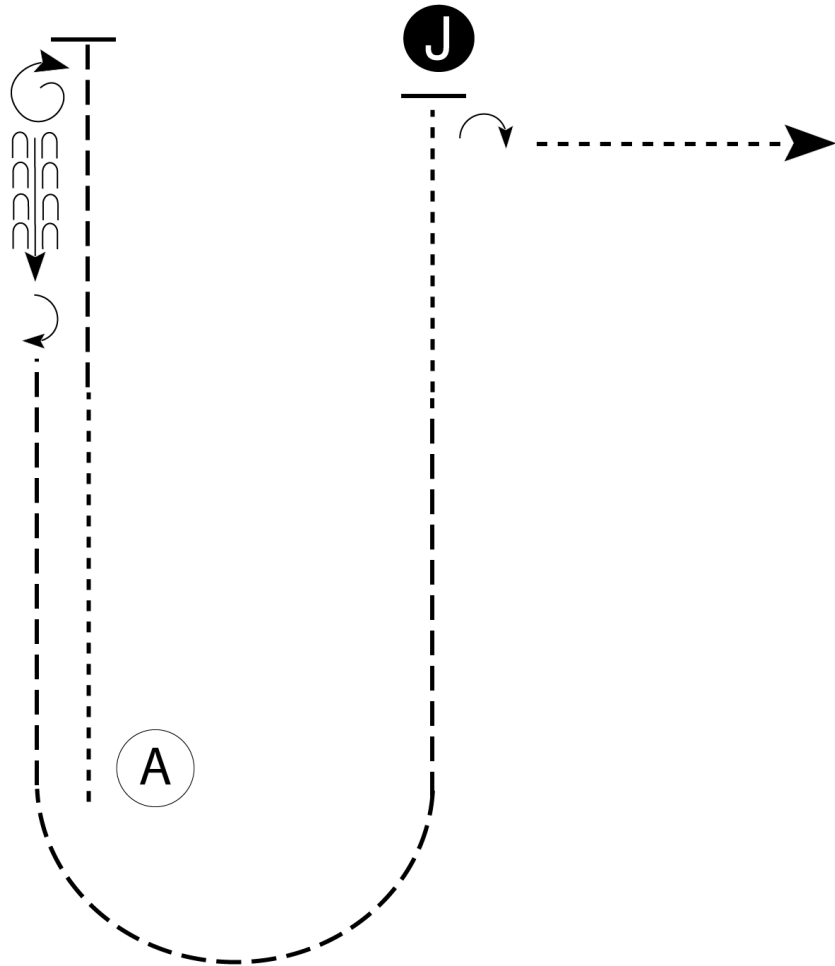

Be ready at A.

1. Walk halfway from A to Judge.
2. Trot until even with judge.
3. Stop and perform a 360 degree turn.
4. Back approximately two horse lengths.
5. Perform a 180 degree turn.
6. Trot to and around A and halfway to judge.
7. Walk to judge.
8. Stop and set up for inspection.
9. When dismissed, perform a 90 degree turn.
10. Walk straight away from judge.

Follow the instructions of your ring steward.

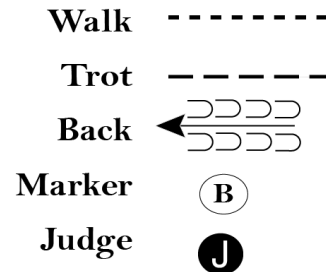

[S/2-77]

Pattern Provided by:

# Bronze Classic

## Horsemanship (All W/T)

Show Date: 07-19-2024

w w w . H o r s e S h o w P a t t e r n s . c o m

w w w . H o r s e S h o w P a t t e r n s . c o m

(B)

(A)

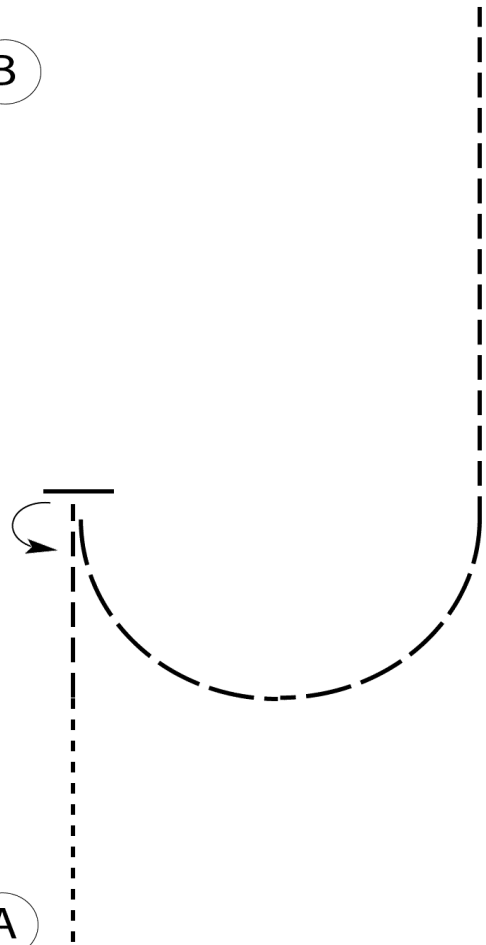

Be ready at A.

1. Walk halfway to center of pattern.
2. Jog to center of pattern.
3. Stop and perform a 180 degree turn left.
4. Extended jog in a half circle to the left.
5. Jog until even with B.

Pattern is over once you have passed B at the jog.

Follow the directions of your ring steward.

Walk	-----
Jog	- - - - -
Extended Jog	— — — —
Lope	—————
Lead Change	
Back	
Marker	(B)

[WH/WT-76]

Pattern Provided by:

# Bronze Classic

## Horsemanship (All Loping)

Show Date: 07-19-2024

w w w . H o r s e S h o w P a t t e r n s . c o m

w w w . H o r s e S h o w P a t t e r n s . c o m

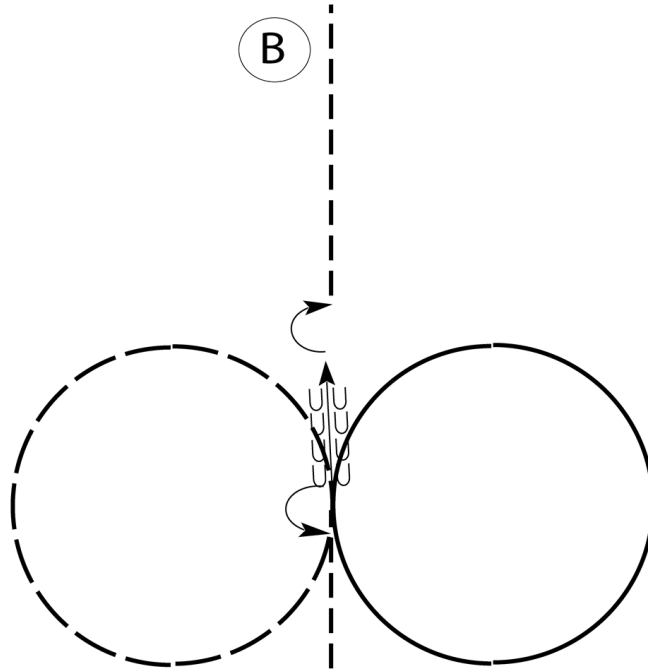

Be ready at A.

1. Walk halfway to center.
2. Jog to center.
3. Lope a circle to the right.
4. Extended jog circle to the left.
5. Stop at center.
6. Turn 1/2 a turn to the left.
7. Back approximately one horse length.
8. Turn 1/2 turn to the right.
9. Jog to B.

Pattern is over once you have passed B at the jog.

Follow the directions of your ring steward.

<b>Walk</b>	-----
<b>Jog</b>	- - - - -
<b>Extended Jog</b>	- - - - -
<b>Lope</b>	—————
<b>Lead Change</b>	— / —
<b>Back</b>	← — — — —
<b>Marker</b>	⊙ B

[WH/2-75]

Pattern Provided by:

CLE ELUM TRAIL 2024  
 ALL BLOCK 1 CLASSES W/T  
 CLASS 140 TO 143

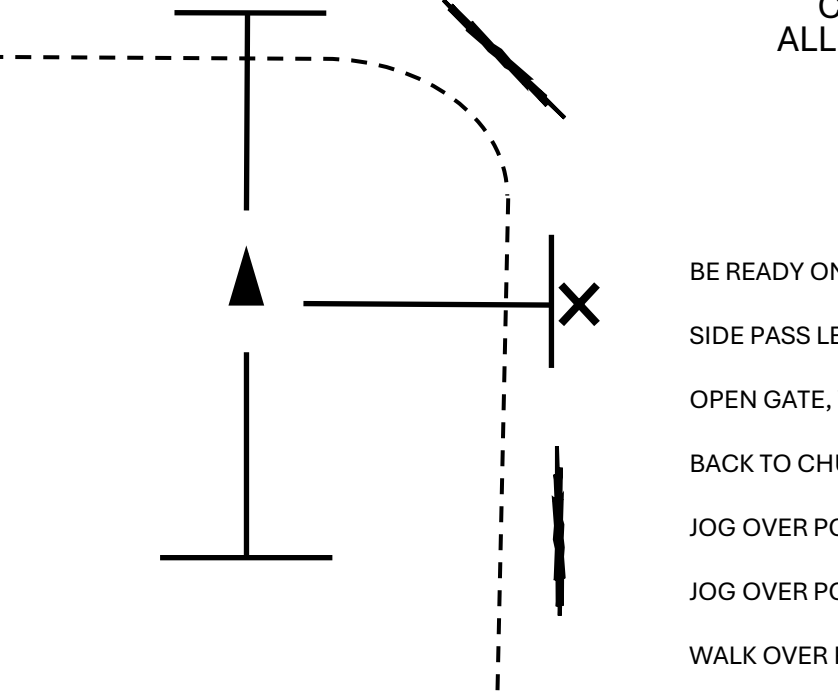
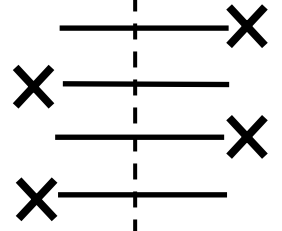
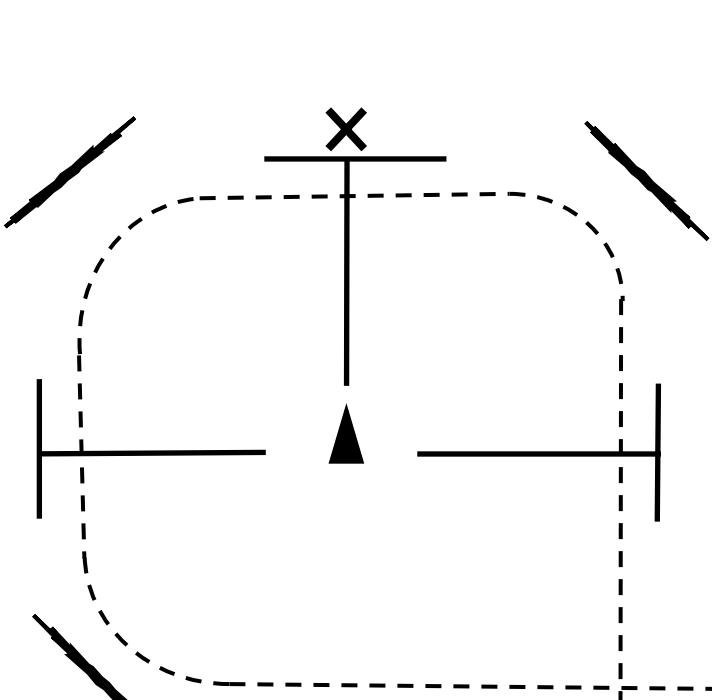

- BE READY ON POLE
- SIDE PASS LEFT TO GATE
- OPEN GATE, WALK THROUGH, CLOSE GATE
- BACK TO CHUTE, TURN 90 DEGREES RT
- JOG OVER POLES
- JOG OVER POLES
- WALK OVER POLES AND OUT

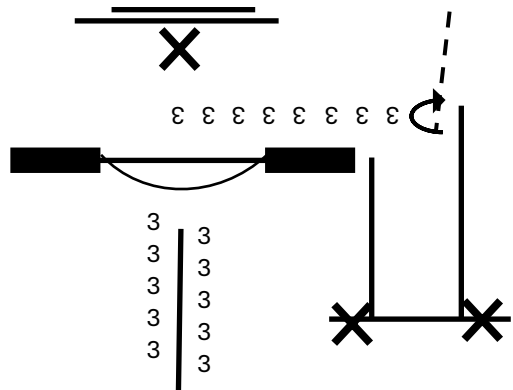

START

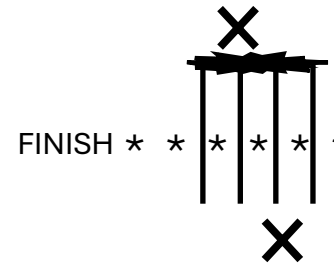
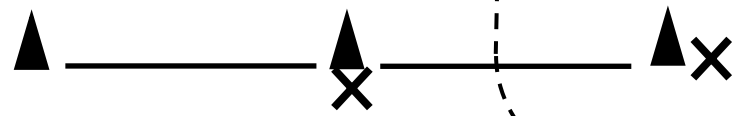

FINISH \* \* \* \* \*

WALK	* * * * *
JOG	- - - - -
LOPE	_____
BACK	ε ε ε ε ε
SIDE PASS	∞ ∞ ∞ ∞ ∞



CLE ELUM TRAIL 2024  
 ALL BLOCK 2 CLASSES  
 CLASS 144 TO 148

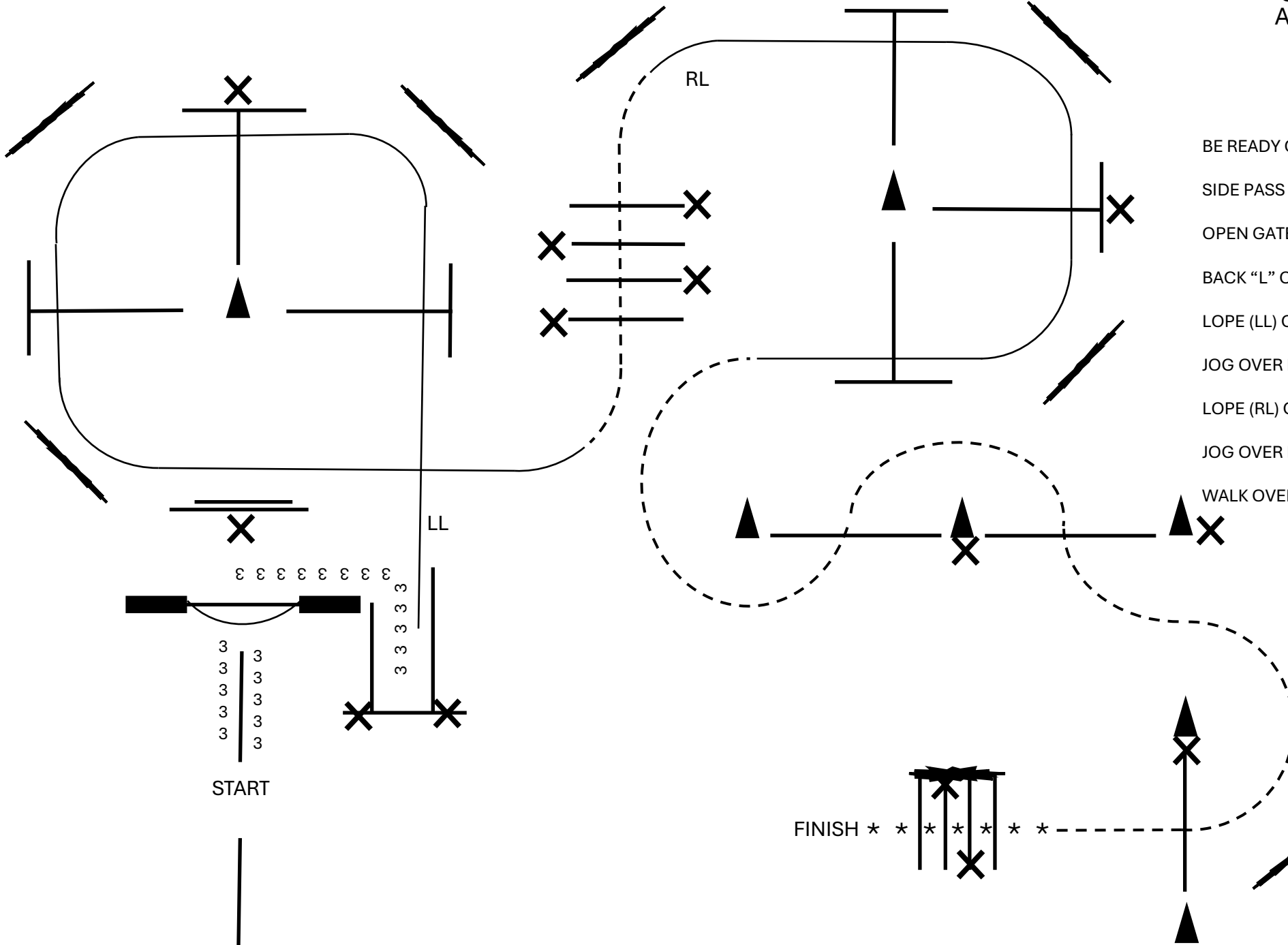

- BE READY ON POLE
- SIDE PASS LEFT TO GATE
- OPEN GATE, WALK THROUGH, CLOSE GATE
- BACK "L" CHUTE
- LOPE (LL) OUT OF CHUTE AND OVER POLES
- JOG OVER POLES
- LOPE (RL) OVER POLES
- JOG OVER POLES AND THROUGH CONES
- WALK OVER POLES AND OUT

WALK	* * * * *
JOG	- - - - -
LOPE	—————
BACK	ε ε ε ε ε
SIDE PASS	∞ ∞ ∞ ∞ ∞

CLE ELUM TRAIL 2024  
 BLOCK 3 CLASS 159  
 NON- PRO SWEEPSTAKES (AM & YOUTH)

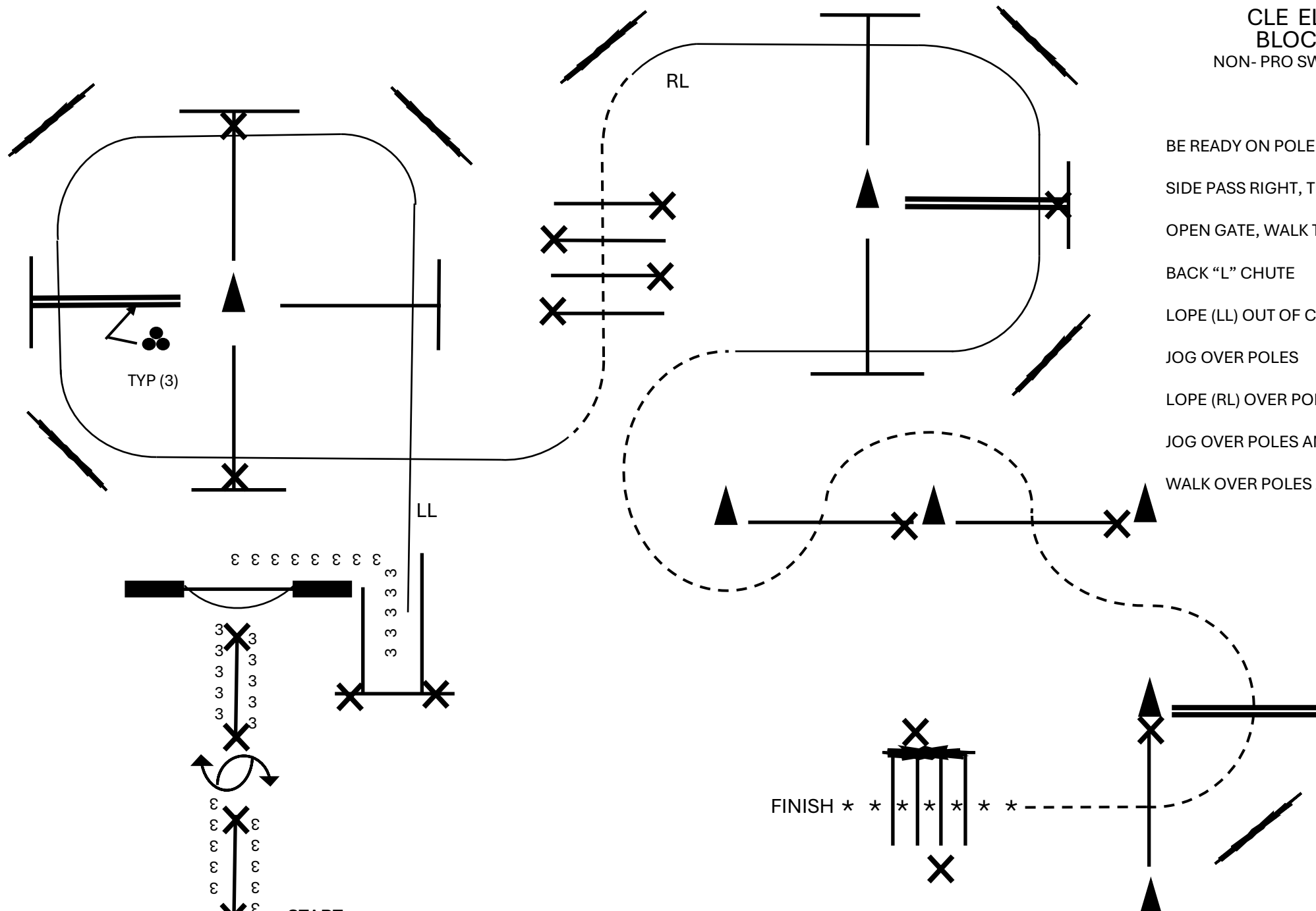

- BE READY ON POLE
- SIDE PASS RIGHT, TURN AROUND, SIDE PASS LEFT TO GATE
- OPEN GATE, WALK THROUGH, CLOSE GATE
- BACK "L" CHUTE
- LOPE (LL) OUT OF CHUTE AND OVER POLES
- JOG OVER POLES
- LOPE (RL) OVER POLES
- JOG OVER POLES AND THROUGH CONES
- WALK OVER POLES AND OUT

WALK	* * * * *
JOG	- - - - -
LOPE	_____
BACK	ε ε ε ε ε
SIDE PASS	∞ ∞ ∞ ∞ ∞

CLE ELUM TRAIL 2024  
 ALL BLOCK 3 CLASSES  
 CLASS 149 TO 158

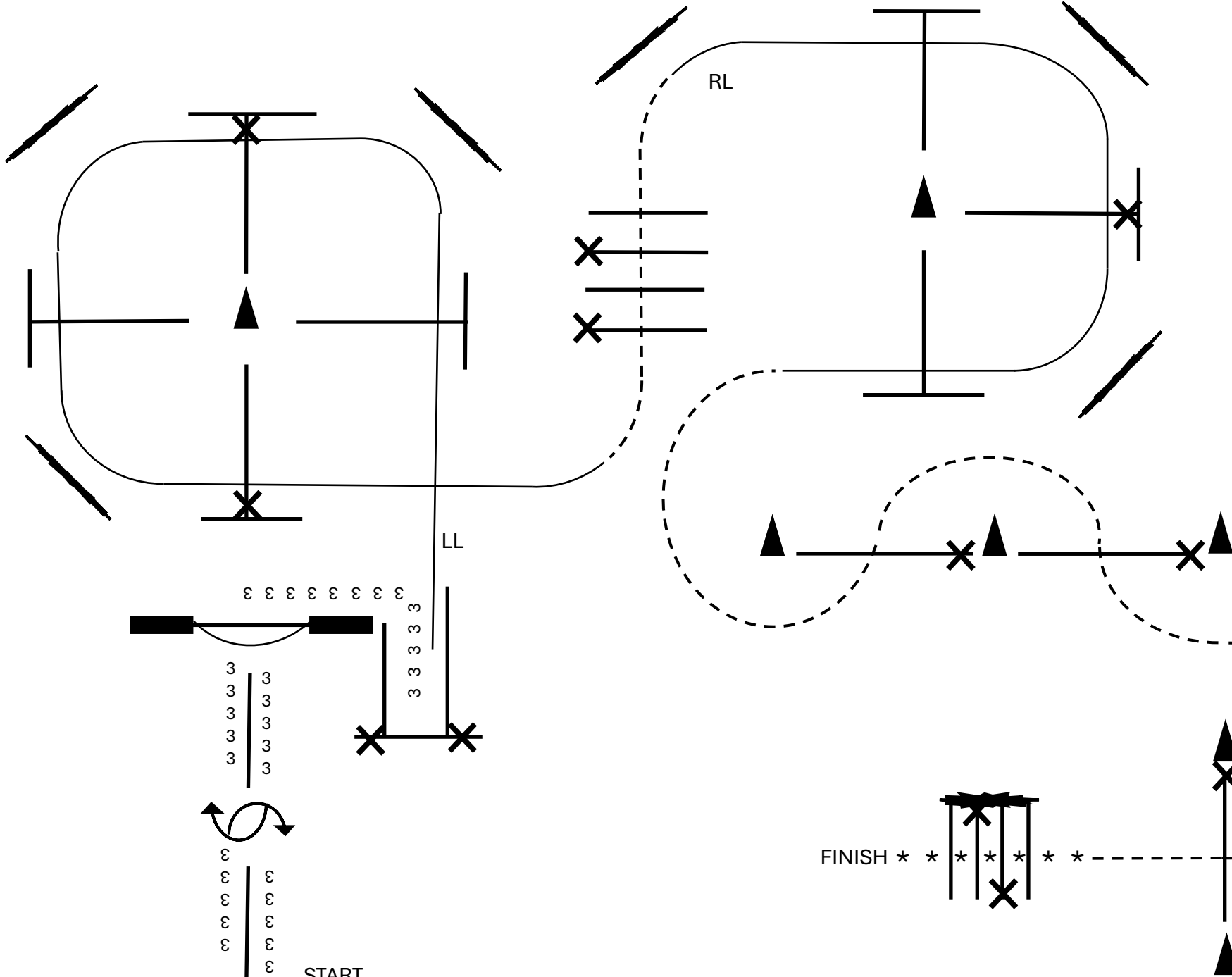

- BE READY ON POLE
- SIDE PASS RIGHT, TURN AROUND, SIDE PASS LEFT TO GATE
- OPEN GATE, WALK THROUGH, CLOSE GATE
- BACK "L" CHUTE
- LOPE (LL) OUT OF CHUTE AND OVER POLES
- JOG OVER POLES
- LOPE (RL) OVER POLES
- JOG OVER POLES AND THROUGH CONES
- WALK OVER POLES AND OUT

WALK	* * * * *
JOG	-----
LOPE	~~~~~
BACK	ε ε ε ε ε
SIDE PASS	∞ ∞ ∞ ∞ ∞

START

FINISH

# Bronze Classic

## Western Riding

Show Date: 07-19-2024

### LEVEL I WESTERN RIDING PATTERN 6

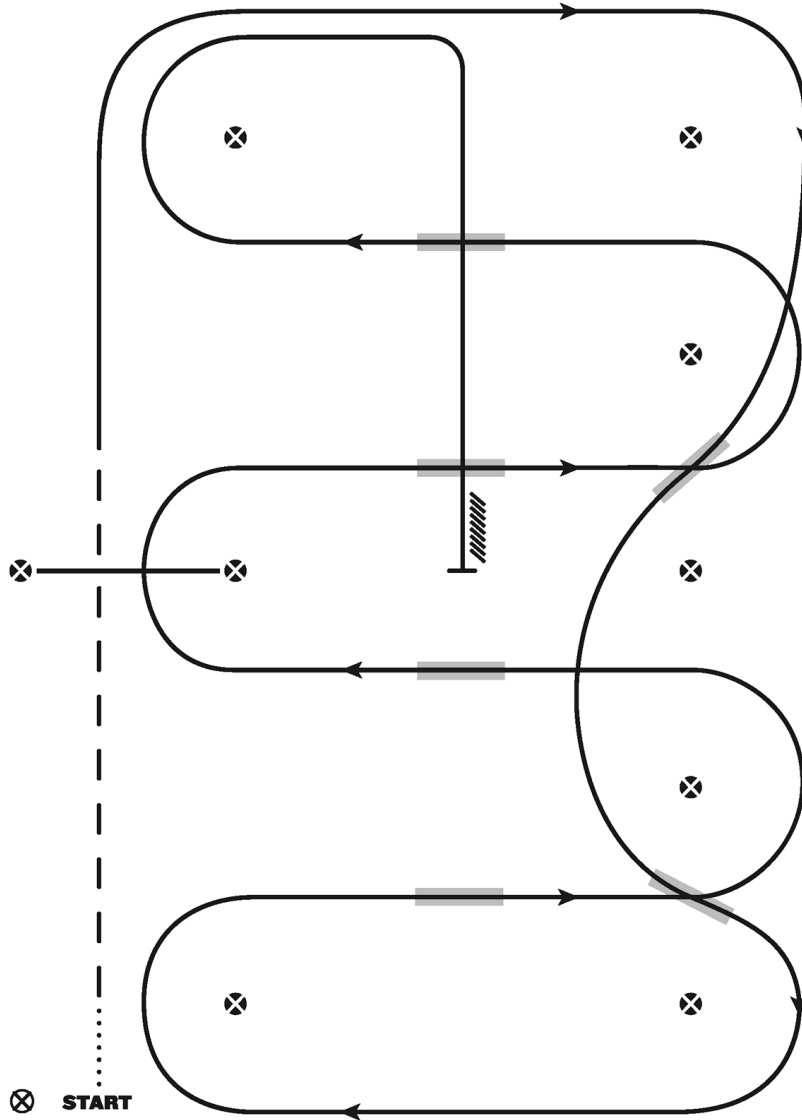

**LEGEND**

- ..... Walk
- - - - - Jog
- Lope
- /////// Back
- Lead Changing Area

1. Walk at least 15 feet from start cone to the first marker, transition to jog, jog over log.
2. Transition to the lope right lead & lope around end
3. First line change
4. Second line change, lope around the end of arena
5. First crossing change
6. Second crossing change
7. Lope over log
8. Third crossing change
9. Fourth crossing change
10. Lope up the center, stop & back

Revised 06-07-2021

[WR/GP-6]

Pattern Provided by:

www.HorseShowPatterns.com

www.HorseShowPatterns.com

# Bronze Classic

## Western Riding

Show Date: 07-19-2024

### WESTERN RIDING - PATTERN 6

#### LEGEND

.....	Walk
- - - -	Jog
————	Lope
//////	Back
————	Lead Changing Area

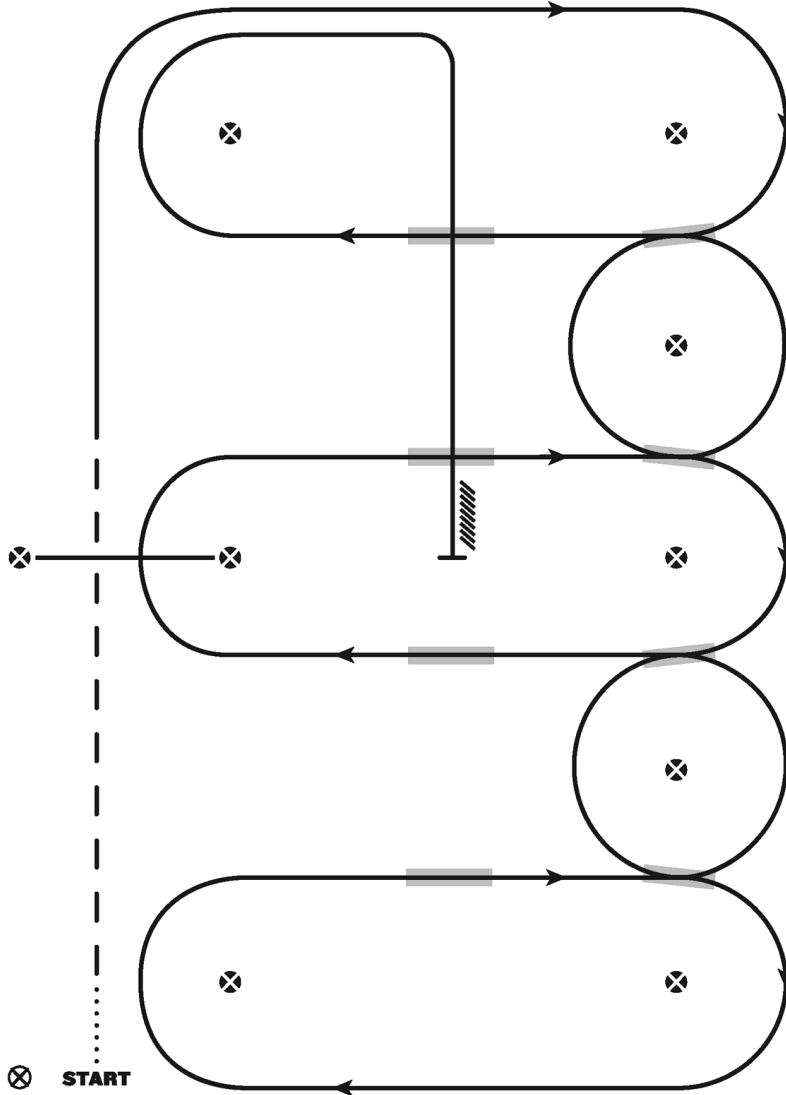

1. Walk at least 15 feet from start cone to the first marker, transition to jog, jog over log
2. Transition to the lope right lead & lope around end
3. First line change
4. Second line change
5. Third line change
6. Fourth line change lope around the end of arena
7. First crossing change
8. Second crossing change
9. Lope over log
10. Third crossing change
11. Fourth crossing change
12. Lope up the center, stop & back

Revised 06-07-2021

[WR/OP-6]

Pattern Provided by:

# Bronze Classic

## Hunt Seat Equitation (All W/T)

Show Date: 07-19-2024

w w w . H o r s e S h o w P a t t e r n s . c o m

w w w . H o r s e S h o w P a t t e r n s . c o m

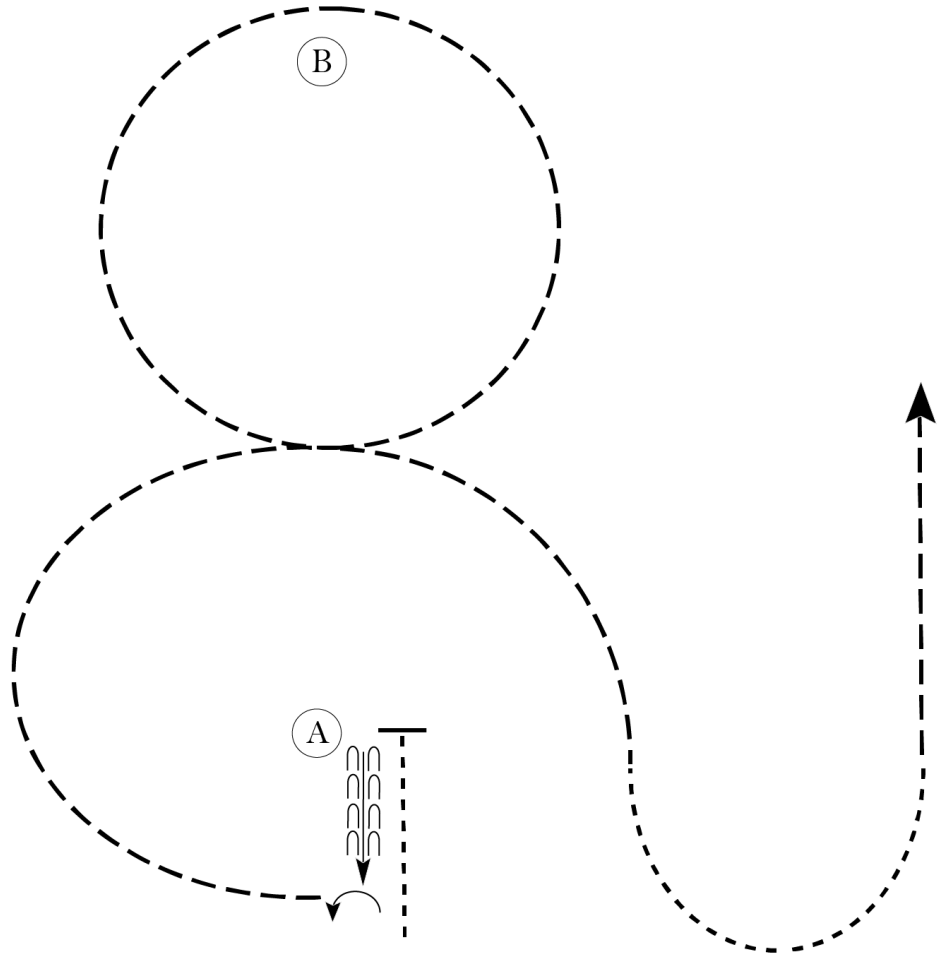

Be ready before A.

1. Walk to A. Back approximately one horse length the perform a 1/4 turn on the forehand left.
2. Posting trot on the left diagonal to center
3. Change diagonals and trot a circle around B.
4. Sitting trot in center and trot until even with A.
5. Walk a half circle.
6. Posting trot on the right diagonal to exit.

Follow the instructions of your ring steward.

Walk	-----
Trot	- - - - -
Extended Trot	-----
Canter	—————
Leg Yield	
Lead Change	↙ ↘
Back	← ← ← ← ←
Marker	⊙
Sidepass	← ← ← ← ←
Hand Gallop	-----

[HSE/WT-72]

Pattern Provided by:

# Bronze Classic

## Hunt Seat Equitation

Show Date: 07-19-2024

w w w . H o r s e S h o w P a t t e r n s . c o m

w w w . H o r s e S h o w P a t t e r n s . c o m

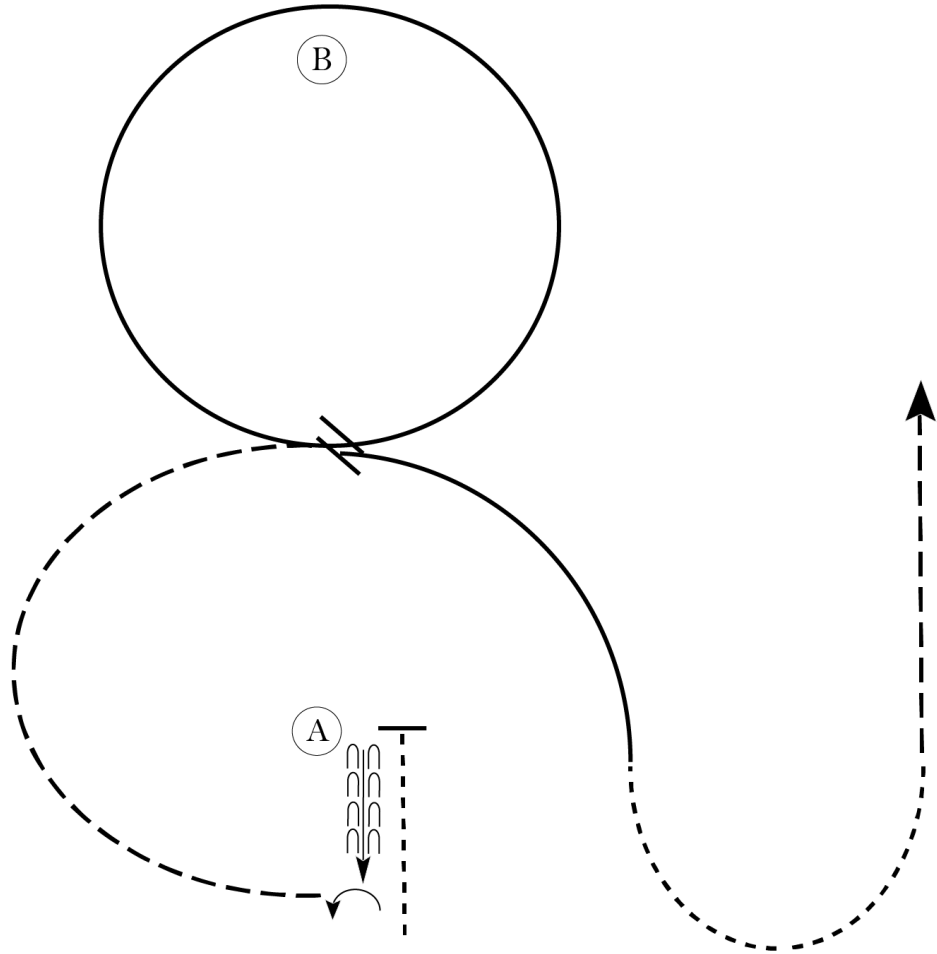

Be ready before A.

1. Walk to A. Back approximately one horse length the perform a 1/4 turn on the forehand left.
2. Posting trot on the left diagonal to center
3. Canter a circle around B on the left lead.
4. Change leads in the center and center on the right lead until even with A.
5. Walk a half circle.
6. Posting trot on the right diagonal to exit.

Follow the instructions of your ring steward.

Walk	-----
Trot	- - - - -
Extended Trot	— — — — —
Canter	—————
Leg Yield	
Lead Change	↙ ↘
Back	← ← ← ← ←
Marker	⊙
Sidepass	← — — — — →
Hand Gallop	— — — — —

[HSE/2-72]

Pattern Provided by: